

## 2857864 - Load-bearing crossbar T3030BH-6S

Cross arm type	H-pole
Pole distance	3m
Phase distance	3m
Pole fastening	Bolt with bolt sleeve

### Crossbar profile P6 (standing)

Weight: (kg/m)	10.52
Cross section: (mm <sup>2</sup> )	3897
Material:	Extruded aluminum, brown anodized
Alloy:	AlMgSi 6082-T6
Moment of resistance: (mm <sup>3</sup> )	W <sub>x</sub> = 233 884 W <sub>y</sub> = 87 555
Area moment of inertia: (mm <sup>4</sup> )	I <sub>x</sub> = 28 325 925 I <sub>y</sub> = 3 852 424
Center distance for I <sub>x</sub> : (mm)	C <sub>x</sub> = 121,11
Center distance for I <sub>y</sub> : (mm)	C <sub>y</sub> = 44,00
Minimum yield strength 0,2: (N/mm <sup>2</sup> )	250
Minimum breaking load: (N/mm <sup>2</sup> )	290

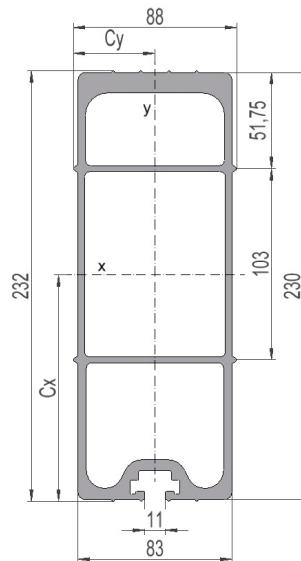

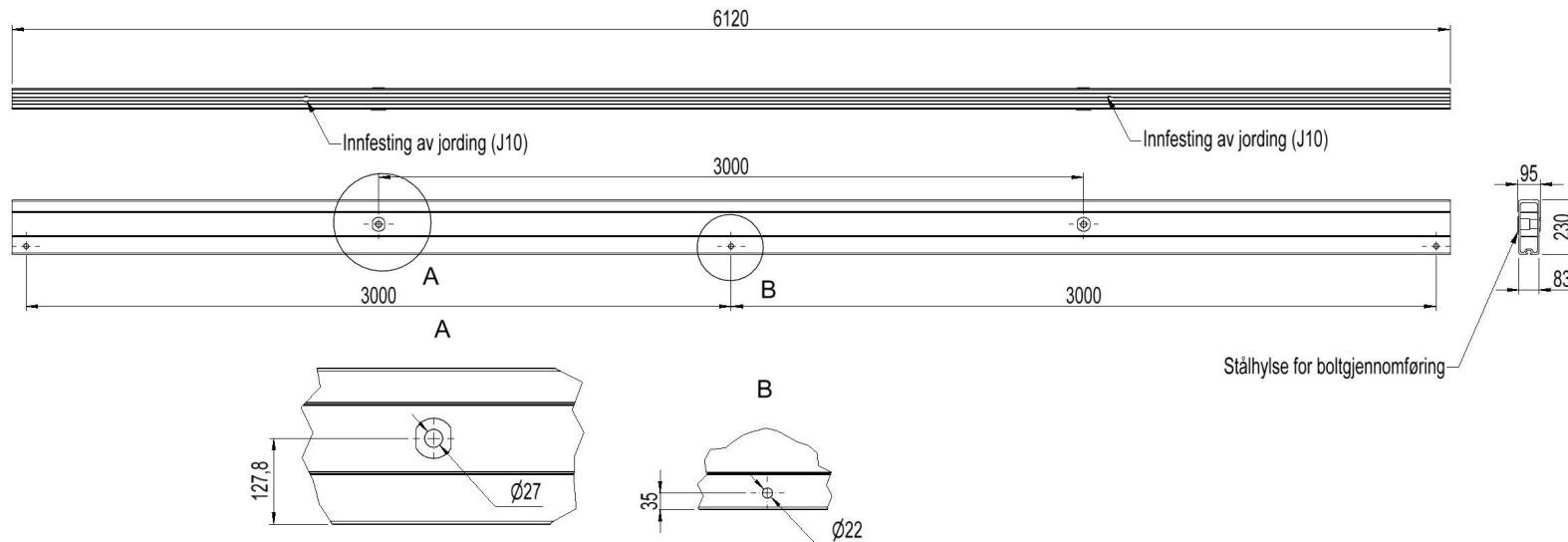

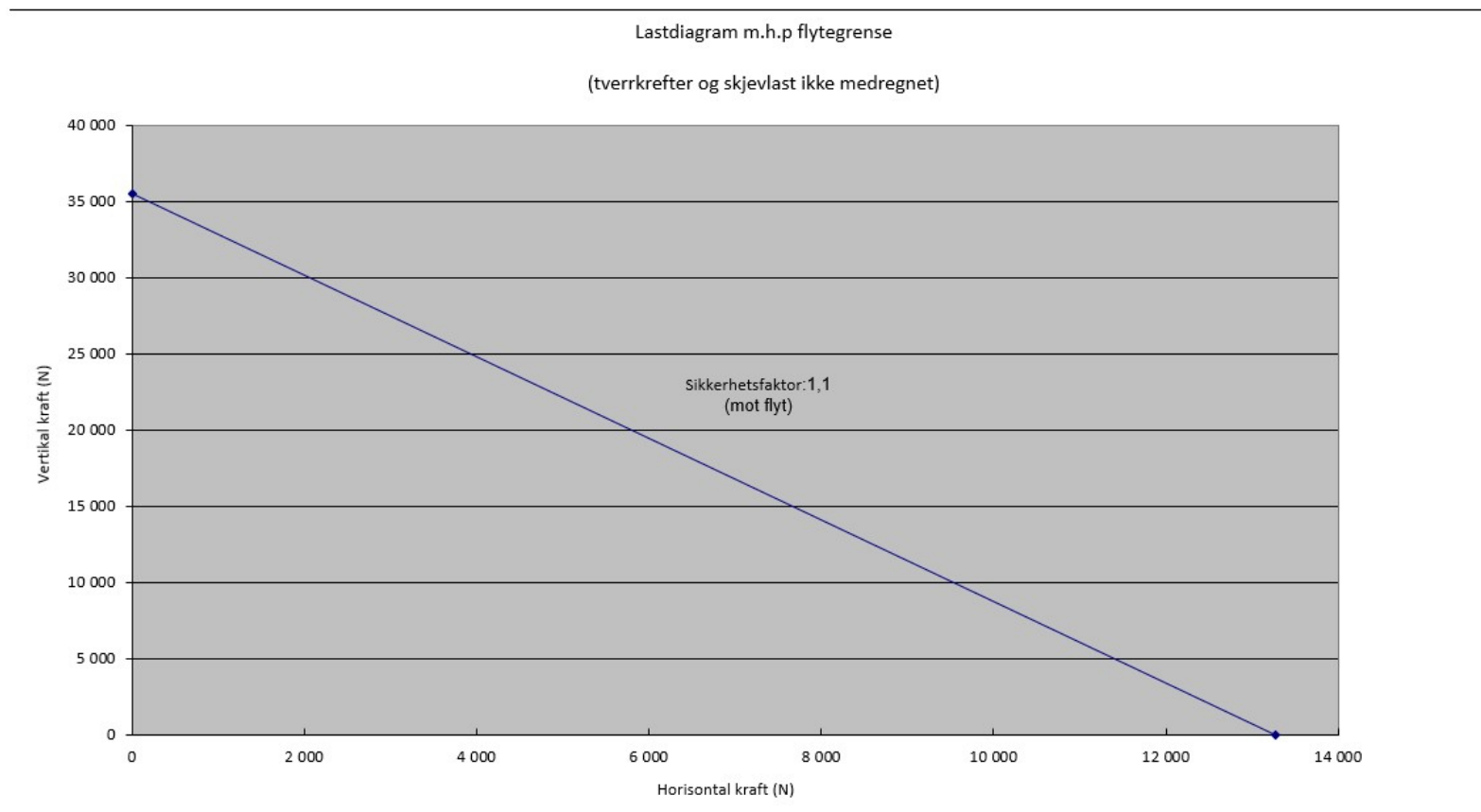

Total bøyning travers i forhold til last

