

2857851 - Insulator bracket FAS65-127-4x16

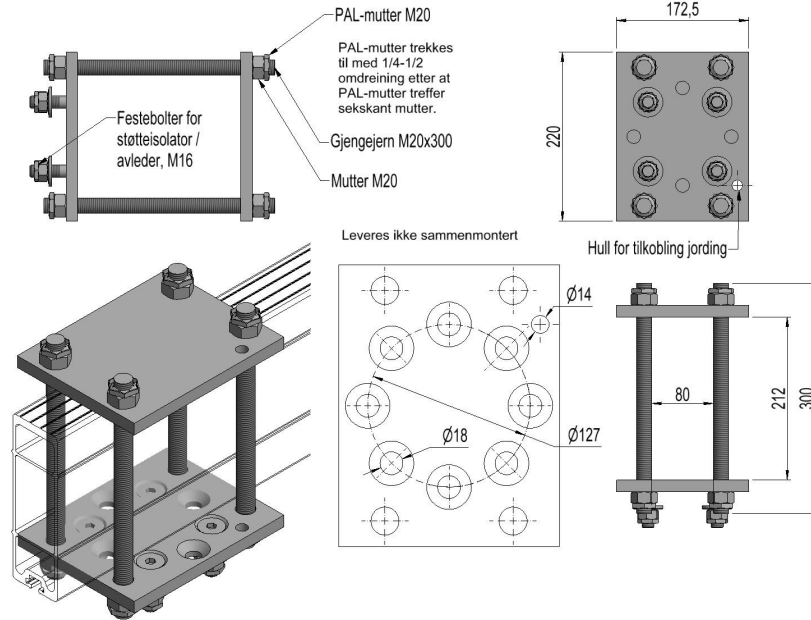

<p>Description</p>	<p>Insulator bracket. For crossbar P5, width 65mm. For mounting of overvoltage surge arrester or insulator onto crossbar. Hole pattern is Ø127, 4xM16. Other hole pattern on request.</p>
<p>Unit</p>	<p>PSC</p>
<p>Weight</p>	<p>7,2 kg</p>
<p>Material</p>	<p>Aluminium</p>