

2837498 - Avsp.trav TA4545BH-8S

Mastetype	H-mast
Masteavstand	4,5m
Faseavstand	4,5m
Stolpeinnfesting	Bolt m/bolthylse

Traversprofil P8 (liggende)

Vekt: (kg/m)	16.982
Areal: (mm ²)	6290
Materiale:	Aluminiumsprofil, bruneloksert
Legering:	AlMgSi 6082-T6
Motstandsmoment: (mm ³)	W _x = 272 777 W _y = 265 967
Annet arealmoment: (mm ⁴)	I _x = 22 101 736 I _y = 21 543 364
Senteravstand for I _x : (mm)	C _x = 81,03
Senteravstand for I _y : (mm)	C _y = 81,00
Minimum flytegrense 0,2: (N/mm ²)	250
Minimum bruddgrense: (N/mm ²)	290

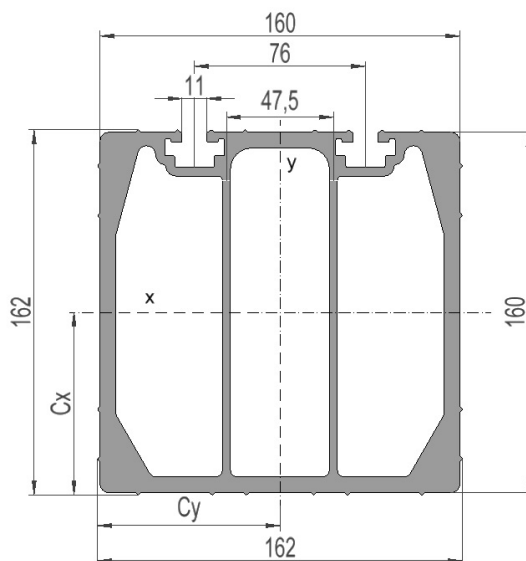

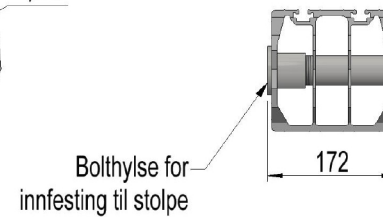
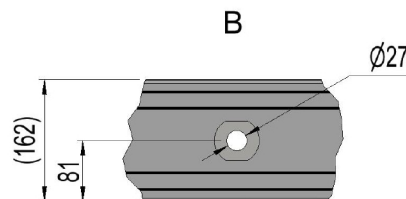
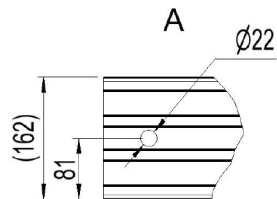
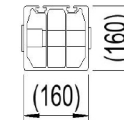
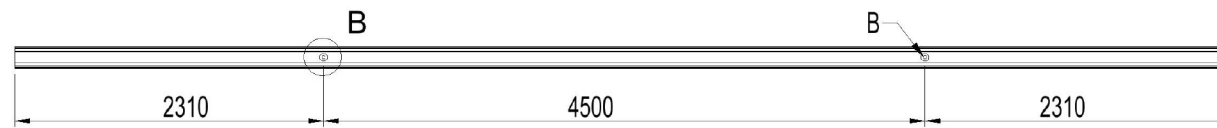

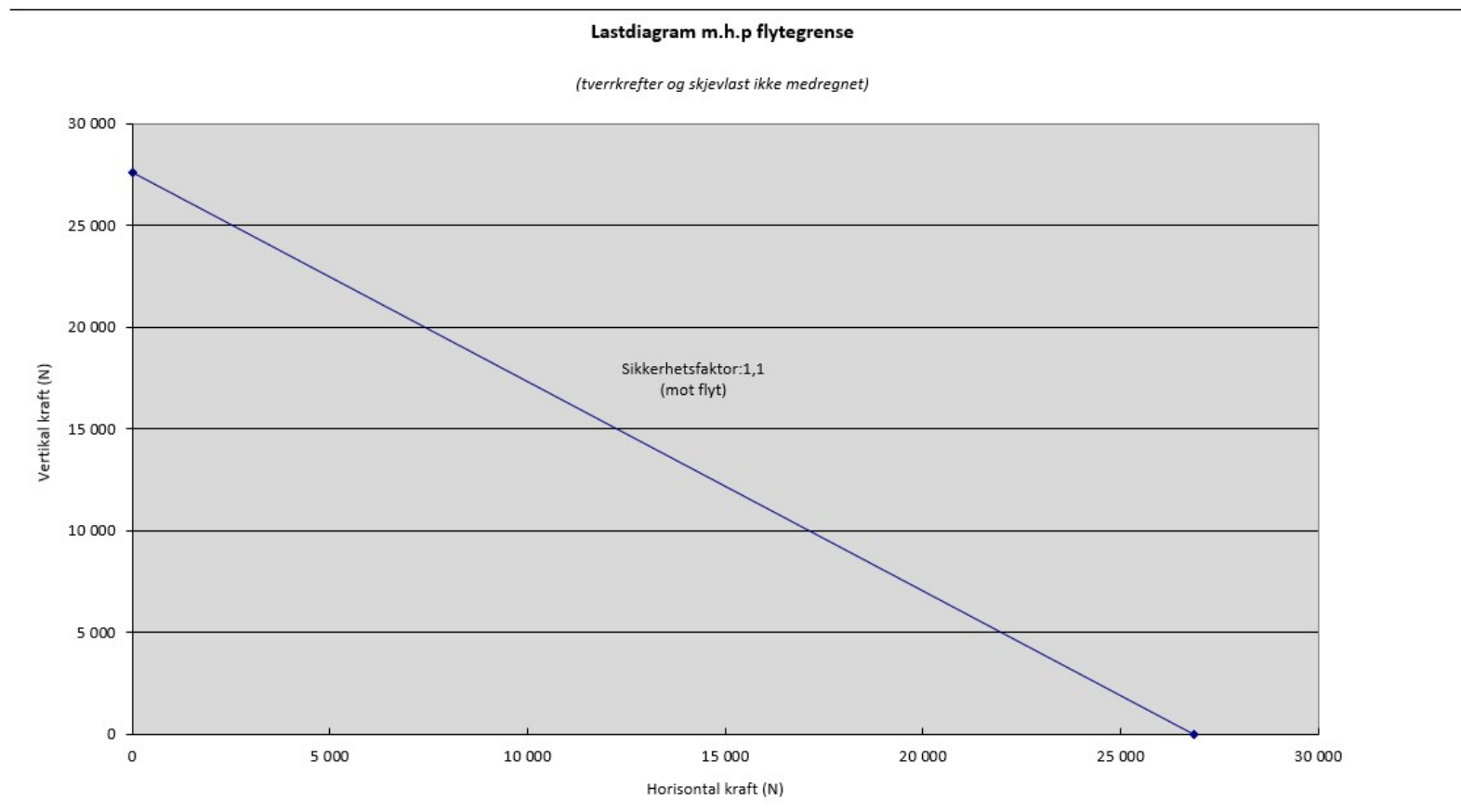

Total bøyning travers i forhold til last

