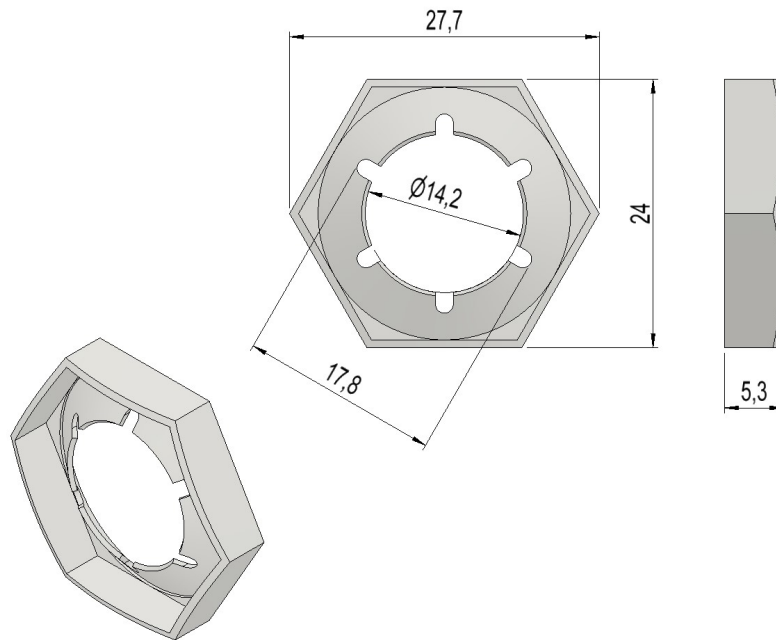

2836450 - PALmutter PAL-M16 VF DIN7967

Beskrivelse	Til låsing av mutter (muttersikring). Ett bedre alternativ enn kontramutter.
Enhet	STK
Vekt	0,003 kg
Materiale	Stål, varmforsinket